

Sealed maintenance-free lead-acid batteries series DTS ASTERION brand are manufactured by AGM technology (electrolyte absorbed in glass fiber separators) and equipped with VRLA valves.

Due to a wide range of batteries and their high performance, are recommended for use in a variety of uninterruptible power supply systems, including exacting electrical appliances (submersible and circulation pumps, boilers of heating systems), emergency power supply and other electrical devices.



Battery construction

Element	Positive plate	Negative plate	Case	Lid	Valve	Terminal	Separator	Electrolyte
Material	Lead dioxide	Lead	ABS		Rubber	Copper	Fiberglass	Acid

Specifications

Nominal voltage.....12 V
 Cell.....6
 Design life.....5 years
 Nominal capacity (25°C)
 20 hours rate (0,25 A; 1,75 V/cell).....5 Ah
 10 hours rate (0,46 A; 1,75 V/cell).....4,6 Ah
 5 hours rate (0,88 A; 1,70 V/cell).....4,4 Ah
 Self-discharge.....3% capacity per month 20°C
 Internal resistance (25°C).....32 mΩ

Operating temperature range

Discharge..... -10÷40°C
 Charge..... -20÷60°C
 Storage..... -20÷60°C
 Maximum dischrge current (25°C).....75A (5sec)
 Cycle mode (2,4÷2,45 V/cell)
 Max.charge current.....1,5 A
 Temperature correction factor.....30 mV/°C
 Standby mode (2,25÷2,3 V/cell)
 Temperature correction factor.....20 mV/°C

Application

- Uninterruptable power supply
- Back up power supply
- Space-heating system
- Renewable energy systems

Performance & characteristics

- AGM technology allows to recombine 99% of the generated gas;
- No restrictions on air transportation;
- Compliance with the UL requirements;
- Lead plates, alloyed by calcium, provide high energy density;
- Maintenance-free. Do not require distillate topping;
- Long service life;
- The battery case is made of flame-retardant ABS

Dimensions (±2mm)

Length, mm.....90
 Width, mm.....70
 Height, mm.....101
 Height over terminals, mm.....105
 Weight (±3%), kg.....1,7

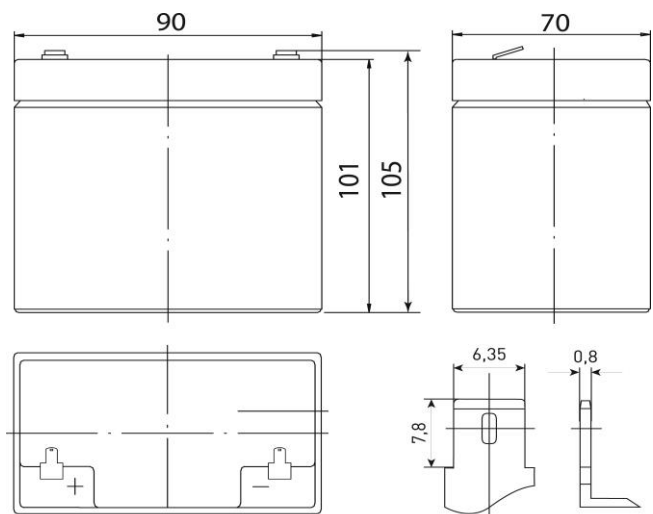

Layout B

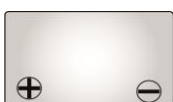

Terminal type F2 type terminal

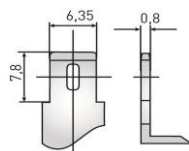

Discharge Constant Current, A (25°C)

V/cell	5 min	10 min	15 min	30 min	1 h	3 h	5 h	10 h	20 h
1,60	18,6	12,0	9,34	5,36	3,14	1,27	0,90	0,49	0,26
1,65	17,7	11,5	8,91	5,10	3,04	1,24	0,88	0,48	0,25
1,70	16,5	10,8	8,39	4,87	2,92	1,24	0,86	0,46	0,25
1,75	15,5	10,1	8,02	4,64	2,75	1,21	0,82	0,45	0,25
1,80	14,8	9,61	7,72	4,39	2,67	1,15	0,79	0,44	0,23

Discharge Constant Power, W/cell (25°C)

V/cell	5 min	10 min	15 min	30 min	1 h	3 h	5 h	10 h	20 h
1,60	33,6	22,2	17,3	9,73	5,87	2,45	1,66	0,93	0,48
1,65	31,3	21,0	16,2	9,32	5,78	2,41	1,63	0,91	0,47
1,70	29,3	19,5	15,6	8,70	5,52	2,38	1,62	0,89	0,46
1,75	27,0	18,3	14,6	8,19	5,26	2,30	1,60	0,87	0,45
1,80	25,2	17,1	13,4	7,75	4,97	2,21	1,57	0,85	0,44

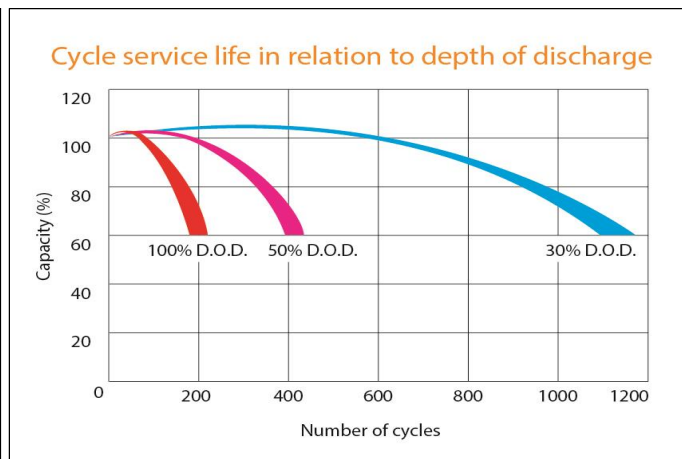
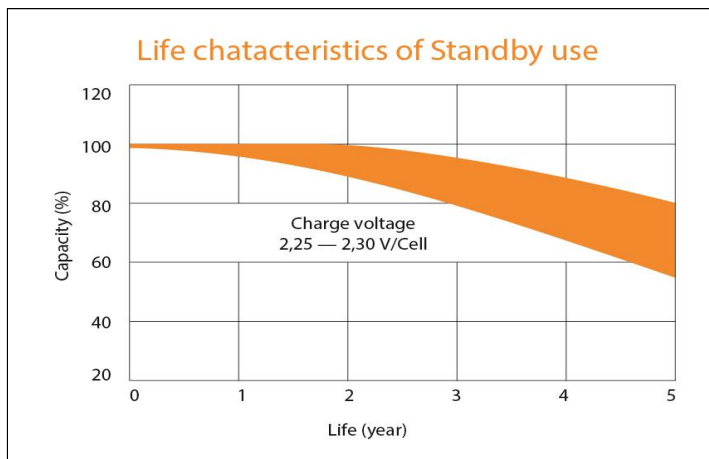
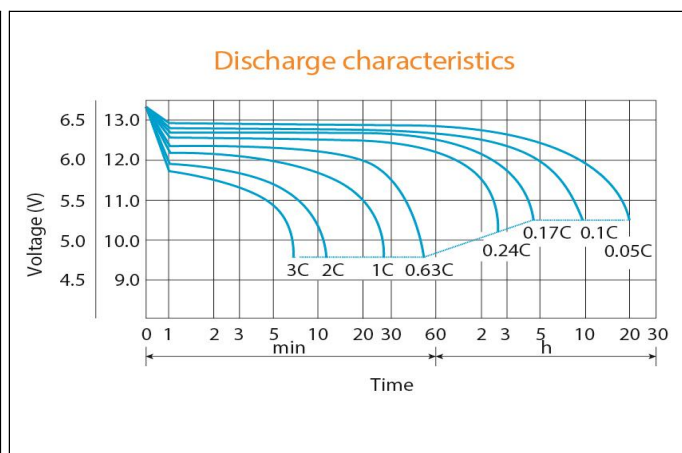
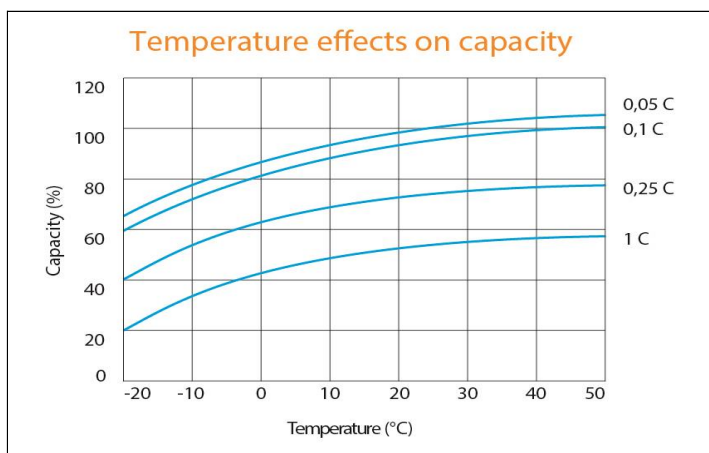

ALL DATA IS SUBJECT TO CHANGE WITHOUT NOTICE