

Lead-acid batteries series DTM ASTERION brand are a clear example of sealed maintenance-free batteries with gas recombination system (VRLA), produced by AGM technology (electrolyte absorbed in glass fiber separator).

DTM is an universal series recommended to be used both in buffer and cyclic modes.

Designed for application in mobile and handheld devices, and due to stable high homogeneity of the internal resistance of products, is ideal for use in back-up power sources and units.

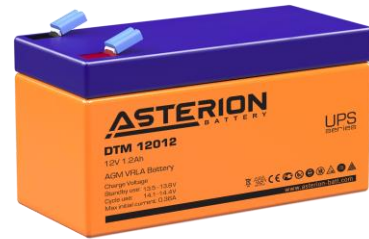

Battery construction

Element	Positive plate	Negative plate	Case	Lid	Valve	Terminal	Separator	Electrolyte
Material	Lead dioxide	Lead	ABS		Rubber	Copper	Fiberglass	Acid

Specifications

Nominal voltage.....	12 V
Cell.....	6
Design life.....	6 years
Nominal capacity (25°C)	
20 hours rate (0,06 A; 1,75 V/cell).....	1,2 Ah
10 hours rate (0,12 A; 1,75 V/cell).....	1,2 Ah
5 hours rate (0,23 A; 1,75 V/cell).....	1,15 Ah
Self-discharge.....	3% capacity per month 25°C
Internal resistance (25°C).....	55 mΩ

Operating temperature range

Discharge.....	-20÷60°C
Charge.....	-10÷60°C
Storage.....	-20÷60°C
Maximum discharge current (25°C).....	18A (5sec)
Cycle mode (2,35÷2,4 V/cell)	
Max.charge current.....	0,36 A
Temperature correction factor.....	30 mV/°C
Standby mode (2,25÷2,3 V/cell)	
Temperature correction factor.....	20 mV/°C

Application

- Uninterruptable power supply
- Back up power supply
- Medical devices
- Control & monitoring systems
- Emergency systems
- Portable devices
- Professional equipment
- Cash-register machine

Layout

F



Terminal type

F1

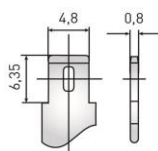

Performance & characteristics

- AGM technology allows to recombine 99% of the generated gas;
- No restrictions on air transportation;
- Compliance with the UL requirements;
- Lead plates, alloyed by calcium, provide high energy density;
- Maintenance-free. Do not require distillate topping;
- Long service life;
- The battery case is made of flame-retardant ABS plastic.

Dimensions (±2mm)

Length, mm.....	97
Width, mm.....	43
Height, mm.....	52
Height over terminals, mm.....	58
Weight (±3%), kg.....	0,61

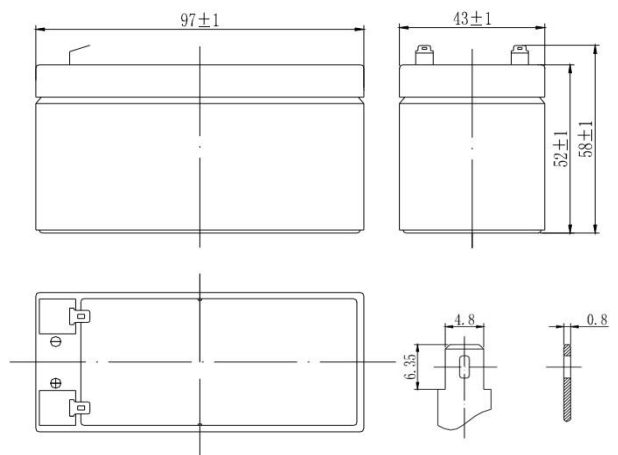

Discharge Constant Current, A (25°C)

V/cell	5 min	10 min	15 min	30 min	1 h	3 h	5 h	10 h	20 h
1,60	5,72	3,85	2,67	1,49	0,89	0,39	0,25	0,13	0,07
1,65	5,42	3,66	2,55	1,43	0,86	0,37	0,24	0,13	0,06
1,70	5,12	3,48	2,43	1,36	0,83	0,36	0,24	0,12	0,06
1,75	4,80	3,28	2,31	1,30	0,79	0,34	0,23	0,12	0,06
1,80	4,48	3,08	2,18	1,23	0,76	0,33	0,22	0,12	0,06

Discharge Constant Power, W/cell (25°C)

V/cell	5 min	10 min	15 min	30 min	1 h	3 h	5 h	10 h	20 h
1,60	9,90	6,24	5,14	2,94	1,77	0,73	0,49	0,26	0,13
1,65	9,28	5,87	4,85	2,78	1,71	0,72	0,48	0,26	0,13
1,70	8,67	5,51	4,58	2,64	1,64	0,69	0,47	0,25	0,13
1,75	8,06	5,15	4,29	2,49	1,56	0,67	0,45	0,24	0,12
1,80	7,47	4,79	4,00	2,33	1,47	0,65	0,44	0,24	0,12

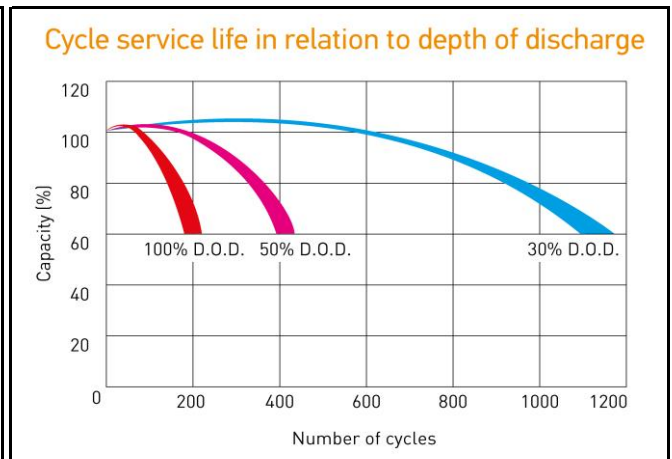
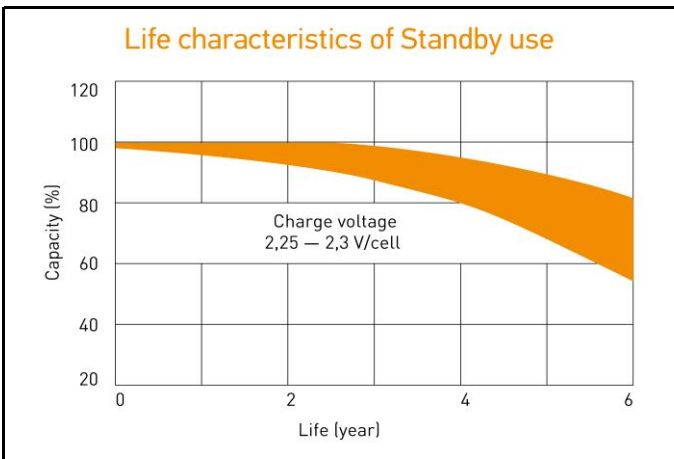
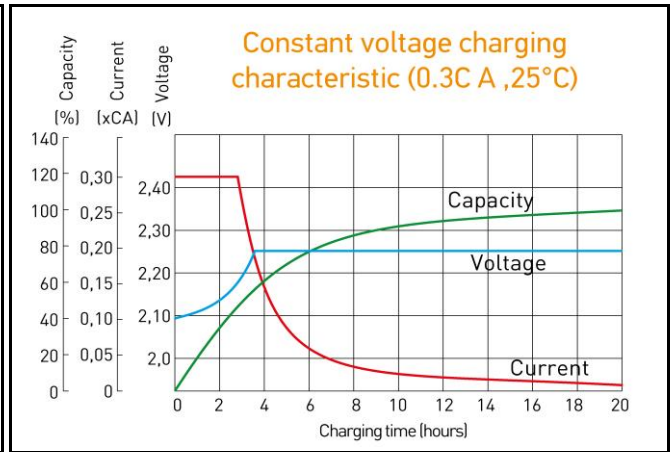
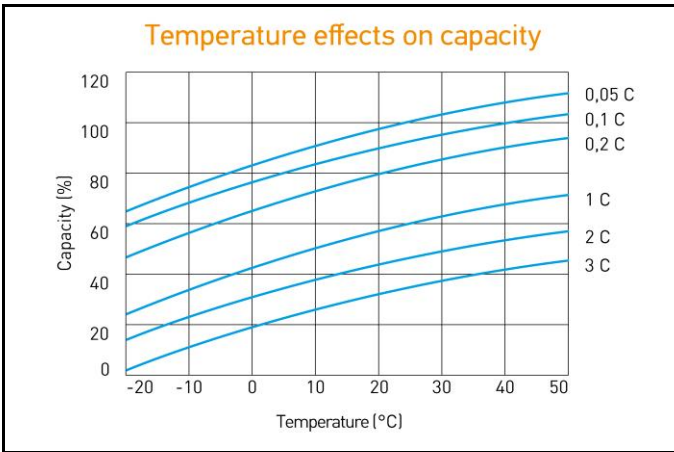

ALL DATA IS SUBJECT TO CHANGE WITHOUT NOTICE